



Power quality management
PRODUCTS CATALOGUE



Power quality management
PRODUCTS CATALOGUE





Contents

A	Dry Power Capacitor	05
B	Intelligent Capacitor	10
C	Low voltage series reactor	15
D	Medium voltage series reactor	18
E	Discharge Reactor	21
F	Power Factor Relay	23
G	Intelligent power factor relay	27
H	Capacitor Duty Contactor	29
I	Switch Series	32
K	Active Harmonic Filter	34

Introduction

BTB ELECTRIC Company is a European standard electrical equipment manufacturer. We provide solutions to improve power quality; products include Capacitors, Harmonic Filter Reactors, Power Factor Controllers, Active Harmonic Filters, Intelligent combined low voltage power capacitors. Our products are manufactured in a high-class fully automated manufacturing unit under expert supervision. Each product goes through various stages of stringent quality checks to ensure the best quality.

Our products are exported throughout the world, and we have earned a great reputation from customers worldwide. We believe that developing the most unique and superior products is the best way to meet/exceed customers' expectations. We strive to provide our clients with new products, advanced designs, and patented innovations so that they can stay on top of their markets.

BTB Electric carries out production in strict accordance with the ISO 9001 quality management system.

Basic Characteristics

Many electrical devices, equipment, and systems need an electromagnetic field for their standard operation. This physical necessity leads to a consumption of reactive power which is used to provide basic function but not any active power. It means that the transmission and distribution system is loaded with this reactive power, and that's not an economically effective use, and therefore, it's penalized by electrical utility companies.

The solution is to use local power factor compensation to provide the required reactive power from power capacitors directly to the appliance to avoid undesired load on the mains network.

Application Fields

Widely used in power distribution systems: State Grid Power Corporation, factory power distribution systems, medical facilities, commercial buildings, communities, and other power distribution systems.

Standard and Environment

Standard	EN 61000-6 IEC/EN 60831-1/ 2, IEC/EN 60076-6 IEC/EN 60947-4-1, IEC/EN 61921 JB/T 9663-2013, JB/T 11067-2011 GB/T15576-2008 2014/30/EU (EMC)
Certificate	CPRI / CQC / LCIE
Ambient air temperature	Storage: -30°C ~ +65°C Operation: -5°C ~ +55°C
Operating altitude	2000m

Calculate the required reactive power

Calculation table

Original cosφ ₁	k coefficient for target cosφ ₂										
	0,90	0,91	0,92	0,93	0,94	0,95	0,96	0,97	0,98	0,99	1,00
0,70	0,54	0,56	0,59	0,62	0,66	0,69	0,73	0,77	0,82	0,88	1,02
0,75	0,40	0,43	0,46	0,49	0,52	0,55	0,59	0,63	0,68	0,74	0,88
0,80	0,27	0,29	0,32	0,35	0,39	0,42	0,46	0,50	0,55	0,61	0,75
0,82	0,21	0,24	0,27	0,30	0,34	0,37	0,41	0,45	0,49	0,56	0,70
0,84	0,16	0,19	0,22	0,25	0,28	0,32	0,35	0,40	0,44	0,50	0,65
0,85	0,14	0,16	0,19	0,22	0,26	0,29	0,33	0,37	0,42	0,48	0,62
0,86	0,11	0,14	0,17	0,20	0,23	0,26	0,30	0,34	0,39	0,45	0,59
0,87	0,08	0,11	0,14	0,17	0,20	0,24	0,28	0,32	0,36	0,42	0,57
0,88	0,06	0,08	0,11	0,14	0,18	0,21	0,25	0,29	0,34	0,40	0,54
0,89	0,03	0,06	0,09	0,12	0,15	0,18	0,22	0,26	0,31	0,37	0,51
0,90		0,03	0,06	0,09	0,12	0,16	0,19	0,23	0,28	0,34	0,48
0,91			0,03	0,06	0,09	0,13	0,16	0,20	0,25	0,31	0,46
0,92				0,03	0,06	0,10	0,13	0,18	0,22	0,28	0,43
0,93					0,03	0,07	0,10	0,14	0,19	0,25	0,40
0,94						0,03	0,07	0,11	0,16	0,22	0,36
0,95							0,04	0,08	0,13	0,19	0,33

Formula for required reactive power

$$Q_c = P * k = P * (\tan\varphi_1 - \tan\varphi_2)$$

$$P = S * \cos\varphi$$

Q_c - Reactive power of the required power capacitor

P - Active power of the load to be corrected

k - Conversion coefficient

φ₁ - Original cosφ

φ₂ - Target cosφ

Calculation example

Load power P = 100 kW

Original cosφ₁ = 0,75

Target cosφ₂ = 0,95

k coeff. (from table) = 0,55

Capacitor reactive power Q_c

$$Q_c = P * k = 100 * 0,55 = 55 \text{ kvar}$$

Basic formulas for detuned power factor corection

$$U_c = \frac{U_N}{1 - \frac{P}{100\%}}$$

U_c - Capacitor voltage – rms value of required voltage of the capacitor. The reactor cause increase of the mains voltage at capacitor

P - Detuning factor – ratio of reactor inductance and capacitor capacitance reactances

$$P = \frac{X_L}{X_C} * 100\%$$

f_r - Serie resonance frequency between reactor and capacitor

U_N - Nominal (rated) mains voltage

f_N - Nominal (rated) mains frequency

$$f_r = f_N \sqrt{\frac{100\%}{P}}$$

Dry Power Capacitor

Application

Three-phased Cylindrical - Dry Power Capacitor is used to correct power factor for motors, low voltage transformers and inside industrial switchboard. It is sometimes used with blocking reactors with harmonics presence.



Salient features

- Dry type, cylindrical aluminium case
- Available for rated voltage 440V / 3-phase connection
- Maximum permissible current: 1.5 In
- Maximum inrush current: 200 In
- Loss: < 0,2W/kVAR
- Statistical Life Expectancy: > 130,000 operating hours
- Equipped with pressure-activated series interrupter
- Compliance to standard IEC/EN 60831-1 & 2

Technical specifications

General characteristics	
Standards	IEC/EN 60831-1/ 2
Type	Dry, Self-healing
Rated Voltage (Un)	240V to 690V
Frequency (fn)	50/60Hz
Connection	3-phase (Internal delta)
Power range	1 to 30 kvar
Capacitance tolerance	-5% / +10%
Dielectric loss	≤ 0.2W / kVAR
Testing voltage between terminals / time	2.15 Un / 10s
Testing voltage between terminals and container / time	4kV / 10s
Lighting impulse test between terminal and container	8kV (Peak)
Maximum permissible voltage	1.1 Un (8hours in evenry 24hours) 1.15 Un (30minutes in evenry 24hours) 1.2 Un (5minutes) 1.3 Un (1minute)
Discharge resistor	Fitted, parameters in the table
Construction	
External terminal box & casing finishing	Extruded aluminum casing
Dielectric	Metallized polypropylene film with Zn/Al alloy
Plate	Zinc-Aluminum alloy (*)
Impregnation	Non-PCB, biodegradable soft resin
Working conditions	
Temperature category	- 25°C to +55°C (class D)
Max altitude	2000 m
Max relative humidity	95%
Maximum permissible current	1.5 In
Maximum inrush current	200 In
Statistical life expectancy	> 130,000 Operating hours (**)
IP rating	IP20
Installation characteristics	
Mounting position	Indoor, upright & horizontal
Fastening / earthing	Threaded M12 stud at the bottom (≤ 15Nm)
Terminals	Screw terminal top deck
Safety features	
Safety Device	Auto disconnect when capacitor has trouble (Pressure Active Series Interrupter)
Protection	IP20
Note	
(*) Special resisity & profile, special edge - Wave-cut (THD ≤4%)	
(**) Respect the manufacturer's technique	

Dimension and structure

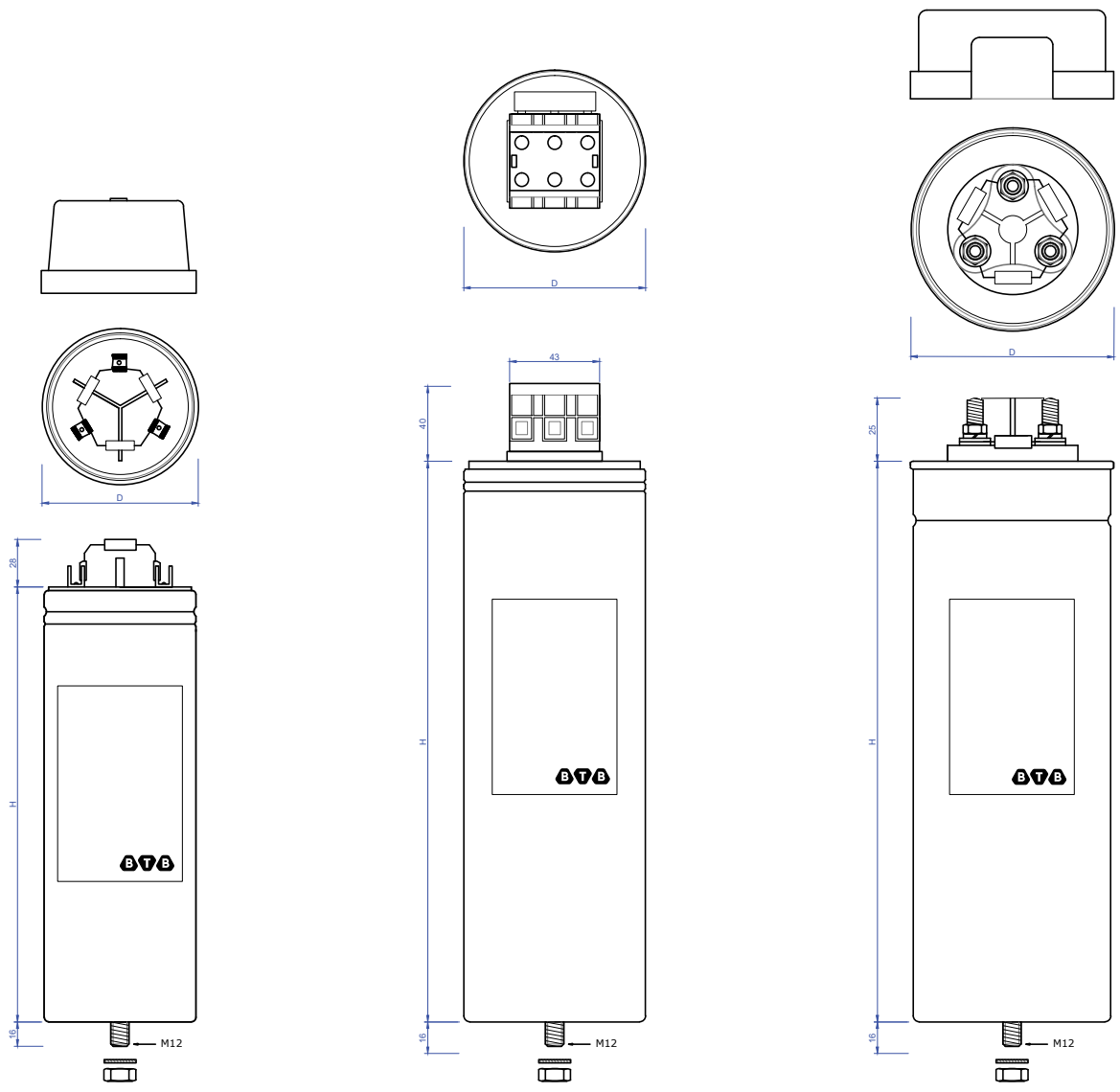

Fig A

Fig B

Fig C

Capacitor code M data sheet - 240V/50Hz

Product Code	U_N	f_N	Q_N	C_N	I_N	Dimension (mm)		Resistor (k Ω)	Weight ± 0.1 (kg)	Figure
	(V)	(Hz)	(kVAR)	(μ F)	(A)	$\varnothing D$	H			
BDC2405M	240	50	5	3x97	12	86	225	100	1.4	Fig B
BDC2410M	240	50	10	3x194	24	100	287	100	2.5	Fig B
BDC2415M	240	50	15	3x276	36	120	287	100	3.0	Fig B

Capacitor code I data sheet - 250V/50Hz

Product Code	U_N	f_N	Q_N	C_N	I_N	Dimension (mm)		Resistor	Weight ± 0.1	Figure
	(V)	(Hz)	(kVAR)	(μ F)	(A)	\varnothing D	H	(k Ω)	(kg)	
BDC2505I	250	50	5	3x85	11.5	75	200	100	1.1	Fig C
BDC2510I	250	50	10	3x170	23	85	300	100	2.0	Fig C
BDC2515I	250	50	15	3x255	35	100	300	100	2.6	Fig C
BDC2520I	250	50	20	3x340	46	116	300	100	3.5	Fig C
BDC2525I	250	50	25	3x424	58	136	300	100	4.6	Fig C

Capacitor code M data sheet - 415V/50Hz

Product Code	U_N	f_N	Q_N	C_N	I_N	Dimension (mm)		Resistor	Weight ± 0.1	Figure
	(V)	(Hz)	(kVAR)	(μ F)	(A)	\varnothing D	H	(k Ω)	(kg)	
BDC4105M	415	50	5	3x31	7	65	206	180	0.5	Fig A
BDC4110M	415	50	10	3x62	14	75	225	220	1.4	Fig B
BDC4115M	415	50	15	3x93	21	86	225	220	1.5	Fig B
BDC4120M	415	50	20	3x123	28	86	287	220	1.8	Fig B
BDC4125M	415	50	25	3x154	35	100	287	220	2.4	Fig B
BDC4130M	415	50	30	3x185	42	100	287	220	2.5	Fig B

Capacitor code I data sheet - 415V/50Hz

Product Code	U_N	f_N	Q_N	C_N	I_N	Dimension (mm)		Resistor	Weight ± 0.1	Figure
	(V)	(Hz)	(kVAR)	(μ F)	(A)	\varnothing D	H	(k Ω)	(kg)	
BDC4105I	415	50	5	3x31	7	63	200	680	0.7	Fig A
BDC4110I	415	50	10	3x62	14	85	200	100	1.3	Fig B/C
BDC4115I	415	50	15	3x93	21	85	300	100	2.0	Fig B/C
BDC4120I	415	50	20	3x123	28	90	300	100	2.3	Fig B/C
BDC4125I	415	50	25	3x154	35	100	300	100	2.6	Fig B/C
BDC4130I	415	50	30	3x185	42	116	300	100	3.2	Fig B/C

Capacitor code M data sheet - 440V/50Hz

Product Code	U_N	f_N	Q_N	C_N	I_N	Dimension (mm)		Resistor	Weight ± 0.1	Figure
	(V)	(Hz)	(kVAR)	(μ F)	(A)	\varnothing D	H	(k Ω)	(kg)	
BDC4405M	440	50	5	3x27	7	60	158	180	0.5	Fig A
BDC4410M	440	50	10	3x55	13	75	225	220	1.3	Fig B
BDC4415M	440	50	15	3x82	20	75	225	220	1.3	Fig B
BDC4420M	440	50	20	3x110	26	75	287	220	2.0	Fig B
BDC4425M	440	50	25	3x137	33	86	287	220	2.1	Fig B
BDC4430M	440	50	30	3x164	39	86	329	220	2.5	Fig B

Capacitor code I data sheet - 440V/50Hz

Product Code	U_N	f_N	Q_N	C_N	I_N	Dimension (mm)		Resistor	Weight ± 0.1	Figure
	(V)	(Hz)	(kVAR)	(μ F)	(A)	\varnothing D	H	(k Ω)	(kg)	
BDC4405I	440	50	5	3x27	7	63	200	680	0.7	Fig A
BDC4410I	440	50	10	3x55	13	75	200	100	1.1	Fig B/C
BDC4415I	440	50	15	3x82	20	75	300	100	1.5	Fig B/C
BDC4420I	440	50	20	3x110	26	85	300	100	2.0	Fig B/C
BDC4425I	440	50	25	3x137	33	90	300	100	2.3	Fig B/C
BDC4430I	440	50	30	3x164	39	100	300	100	2.6	Fig B/C

Capacitor code M data sheet - 480V/50Hz

Product Code	U_N	f_N	Q_N	C_N	I_N	Dimension (mm)		Resistor	Weight ± 0.1	Figure
	(V)	(Hz)	(kVAR)	(μ F)	(A)	\varnothing D	H	(k Ω)	(kg)	
BDC4805M	480	50	5	3x23	6	65	206	180	0.8	Fig A
BDC4810M	480	50	10	3x46	12	75	225	220	1.4	Fig B
BDC4815M	480	50	15	3x69	18	86	287	220	1.8	Fig B
BDC4820M	480	50	20	3x92	24	86	287	220	2.4	Fig B
BDC4825M	480	50	25	3x115	30	86	329	220	2.5	Fig B
BDC4830M	480	50	30	3x138	36	120	287	220	2.9	Fig B

Capacitor code M data sheet - 525V/50Hz

Product Code	U_N	f_N	Q_N	C_N	I_N	Dimension (mm)		Resistor	Weight ± 0.1	Figure
	(V)	(Hz)	(kVAR)	(μ F)	(A)	\varnothing D	H	(k Ω)	(kg)	
BDC5205M	525	50	5	3x19	5	65	206	180	0.5	Fig A
BDC5210M	525	50	10	3x38	11	75	225	220	1.3	Fig B
BDC5215M	525	50	15	3x58	16	75	287	220	1.4	Fig B
BDC5220M	525	50	20	3x77	22	86	287	220	1.8	Fig B
BDC5225M	525	50	25	3x96	27	86	287	220	2.4	Fig B
BDC5230M	525	50	30	3x115	33	86	329	220	2.5	Fig B

Intelligent Capacitor

Application

The BIC series intelligent combined low voltage power capacitor compensation device (intelligent power capacitor) is an intelligent reactive power compensation device applied to 0.4 kV low voltage distribution networks to reduce line loss, improve power factor, and enhance power quality.

This product can be used in industrial areas such as steel, chemical, construction materials, papermaking, textile, mining, electricity, telecommunications, aluminum, shipping ports, tobacco, brewing, carmaking, precision electronics, and precision machinery.

The BIC3 series typically integrates modern measurement and control equipment, power electronics, communication networks, automation controls, capacitors, and other advanced technologies.

The BIC37 series with reactors is designed primarily for high-performance power situations where harmonics and traditional capacitors cannot work. It not only meets reactive power compensation needs and improves power factor but also limits the influence of corresponding harmonics on the capacitor and improves power quality.



Salient features

- New generation box type
- Automatic control
- Communication protocols: Modbus / DL645 protocol
- Protective functions: U / I / THD / over-temperature
- Integrated 7% & 14% Harmonic Resistance
- Reduction in installation time
- Compliance with standard GB/T15576-2008

Technical specifications

B

Intelligent
Capacitor

General characteristics	
Standards	IEC/EN 61921 & GB/T15576-2020
Type	New generation box type, Self-healing
Rated Voltage (Un)	250V to 525V $\pm 20\%$
Frequency (fn)	50Hz $\pm 10\%$
Connection	3-phase
Power range	5 to 60 kvar
Capacitance tolerance	-5% / +10%
Reactance ratio (%)	7% / 14% (for BIC series with reactors)
Dielectric	Metallized polypropylene film with Zn/Al alloy
Impregnation	Non-PCB, biodegradable soft resin
Maximum permissible voltage	1.1 Un (8hours in every 24hours) 1.15 Un (30minutes in every 24hours) 1.2 Un (5minutes) 1.3 Un (1minute)
Discharge resistor	Fitted, parameters in the table
Measurement and control	
Measurement tolerance	Voltage: $\leq \pm 0.5\%$ (0.8~1.2Un), Current: $\leq \pm 0.5\%$ (0.2~1.2In) Active power: $\leq \pm 2\%$, Power factor: $\leq \pm 1\%$, Temperature: $\pm 1^\circ\text{C}$
Protection tolerance	Voltage: $\leq \pm 1\%$, Current: $\leq \pm 1\%$, Temperature: $\pm 1^\circ\text{C}$, Time: $\pm 0.1\text{s}$
Reactive compensation parameters	Reactive power compensation tolerance: $\leq 50\%$ of the min. capacitor capacity, Capacitor switching time: $\geq 10\text{s}$, can be set between 10s and 180s
Reliability parameter	Control accuracy: 100%, Allowable switching times: 1 million times, Capacitor capacity running time attenuation rate: $\leq 1\%$ / year, Capacitor capacity switching attenuation rate: $\leq 0.1\%$ / 10,000 times
Working conditions	
Temperature category	- 25°C to +55°C (class D)
Max altitude	2000 m
Max relative humidity	Relative humidity $\leq 50\%$ at 40°C; $\leq 90\%$ at 20°C
Environmental condition	No harmful gas and steam, no conductive or explosive dust, no severe mechanical vibration
Mounting position	Indoor, upright
THDv	$\leq 4\%$ and $\leq 5\%$ (for BIC series with reactors)
THDi	$\leq 20\%$
Safety features	
Protective function	Over-voltage protection, under-voltage protection, short-circuit protection, over-current protection, over-harmonic protection, over-temperature protection, drive failure protection
Communication monitoring capability	
Communication interface	RS485
Communication protocol	Modbus protocol / DL645

Dimension and structure

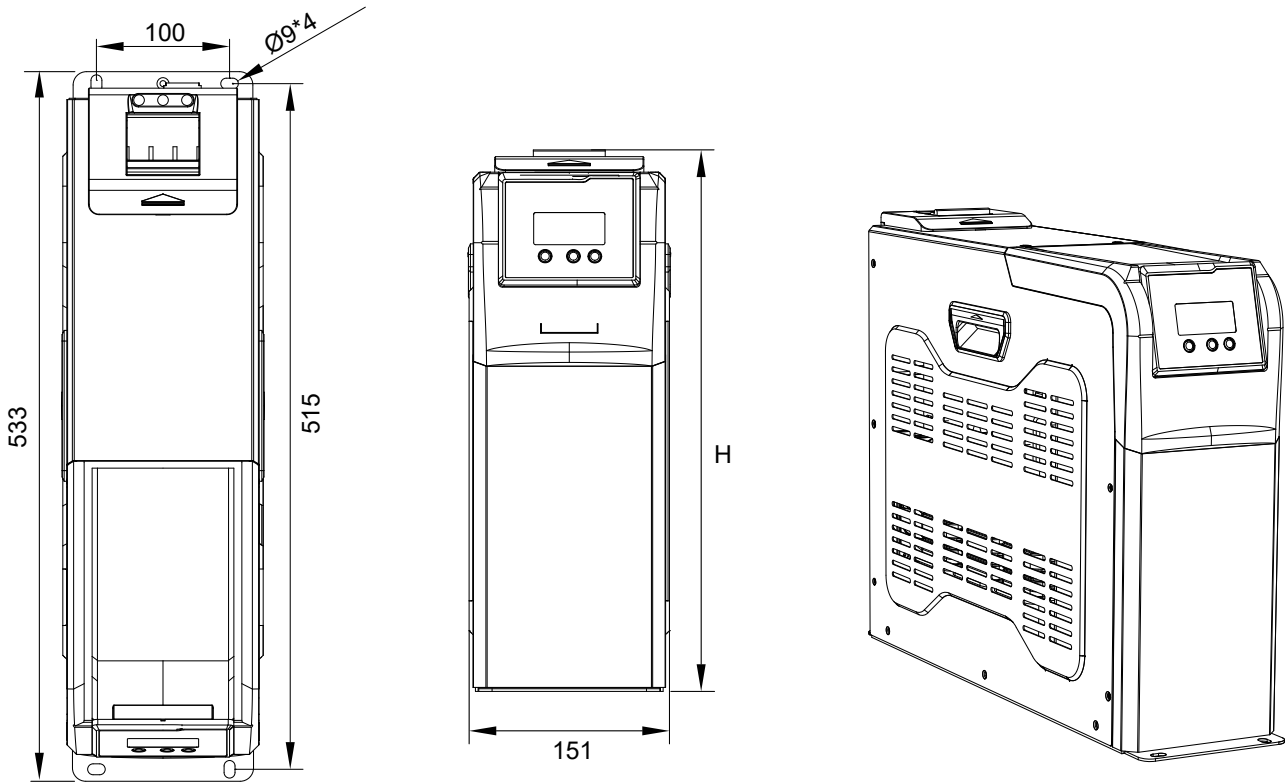

Functional equivalence diagram of intelligent capacitor



The reactor is included in the Intelligent Anti-Harmonic Capacitor.

Intelligent Capacitor data sheet (three phase)

Product Code	U_N (V)	f_N (Hz)	Q_N (kVAR)	Dimension WxDxH (mm)
BIC3-450505	450	50	10	80×395×215
BIC3-451005	450	50	15	80×395×235
BIC3-451010	450	50	20	80×395×235
BIC3-451515	450	50	30	80×395×315
BIC3-452010	450	50	30	80×395×315
BIC3-452020	450	50	40	80×395×315
BIC3-452525	450	50	50	80×395×345
BIC3-453030	450	50	60	80×395×345

When equipped with a controller, only the PFRZ controller can be used.

Intelligent Capacitor data sheet (split phase)

Product Code	U_N (V)	f_N (Hz)	Q_N (kVAR)	Dimension WxDxH (mm)
BIC1-2505	250	50	5	80×395×215
BIC1-2510	250	50	10	80×395×215
BIC1-2515	250	50	15	80×395×235
BIC1-2520	250	50	20	80×395×265
BIC1-2525	250	50	25	80×395×315
BIC1-2530	250	50	30	80×395×315

B
 Intelligent Capacitor

Intelligent anti-harmonic capacitor data sheet (split phase)

Product Code	U_N (V)	f_N (Hz)	Q_N (kVAR)	Reactance ratio	Dimension WxDxH (mm)
BIC17-2805	280	50	5	7%	150x533x357
BIC17-2810	280	50	10	7%	150x533x357
BIC17-2815	280	50	15	7%	150x533x357
BIC17-2820	280	50	20	7%	150x533x357
BIC17-2825	280	50	25	7%	150x533x407
BIC17-2830	280	50	30	7%	150x533x407

Product Code	U_N (V)	f_N (Hz)	Q_N (kVAR)	Reactance ratio	Dimension WxDxH (mm)
BIC114-3005	300	50	5	14%	150x533x357
BIC114-3010	300	50	10	14%	150x533x357
BIC114-3015	300	50	15	14%	150x533x357
BIC114-3020	300	50	20	14%	150x533x357
BIC114-3025	300	50	25	14%	150x533x407
BIC114-3030	300	50	30	14%	150x533x407

Intelligent anti-harmonic capacitor data sheet (three phase)

Product Code	U_N (V)	f_N (Hz)	Q_N (kVAR)	Reactance ratio	Dimension WxDxH (mm)
BIC37-4810	480	50	10	7%	150x533x357
BIC37-4820	480	50	20	7%	150x533x357
BIC37-4830	480	50	30	7%	150x533x407
BIC37-4840	480	50	40	7%	150x533x407
BIC37-4850	480	50	50	7%	270x482x430
BIC37-4860	480	50	60	7%	270x482x430
BIC37-4870	480	50	70	7%	270x482x430

When equipped with controller, can be only used PFRZ controller.

Intelligent anti-harmonic capacitor data sheet (three phase)

Product Code	U_N (V)	f_N (Hz)	Q_N (kVAR)	Reactance ratio	Dimension WxDxH (mm)
BIC314-5210	525	50	10	14%	150x533x357
BIC314-5220	525	50	20	14%	150x533x357
BIC314-5230	525	50	30	14%	150x533x407
BIC314-5240	525	50	40	14%	150x533x407
BIC314-5250	525	50	50	14%	270x482x430
BIC314-5260	525	50	60	14%	270x482x430
BIC314-5270	525	50	70	14%	270x482x430

When equipped with controller, can be only used PFRZ controller.

Accessories (additional purchased)

Secondary current transformer

Three-phase compensation-type secondary current transformer, Code CT1PBIC



Split-phase (mixed) compensation-type secondary current transformer, Code CT3PBIC



Communication cable

Product Code	Length	Picture	Usage
W20BIC	20cm		Connection of two adjacent intelligent capacitors
W80BIC	80cm		Connection of upper and lower layers of intelligent capacitors
W260BIC	260cm		Connection of intelligent capacitors in main and sub cabinet
W300BIC	300cm		Connection of intelligent capacitor and controller

Description of the model

B	IC	3	7	-	48	10	/	10
1	2	3	4		5	6		7

1	Enterprise code: BTB Electric	5	Capacitor voltage: 25: 250V; 28: 280V;	
2	Code: Intelligent Capacitor		30: 300V; 45: 450V; 52: 525V	
3	3: 3 phase; 1: 1 phase	6	Capacitor capacity: 10: 10kVAR; 20: 20kVAR...	
4	Reactance ratio: 7% or 14% (anti-harmonic)	7	2nd capacitor capacity (if any)	

Low voltage reactors

Application

Frequent use of power electronic devices with nonlinear loads leads to harmonic distortion in the electrical system. This non-sinusoidal load causes an increase in the effective current of power capacitors and other components of the system, as well as the possibility of capacitor resonance with other inductive loads. Ultimately, this may lead to problems or even failures in the installation.

The solution is to use detuning (filtering) reactors, which create a series resonant circuit with power capacitors. This detuned system prevents the installation from experiencing resonance effects and also acts as a filter for higher harmonic content. Usually, it is recommended to use detuning reactors for the total voltage distortion THD-U higher than 3%.

Salient features

- Special Design with High-Level Saturation
- Superior Performance
- High-Grade Laminations in Magnetic Circuit
- Easy Pad Termination & Mounting
- Low Power Losses
- Protection from Excess Temperature



Dimension and structure

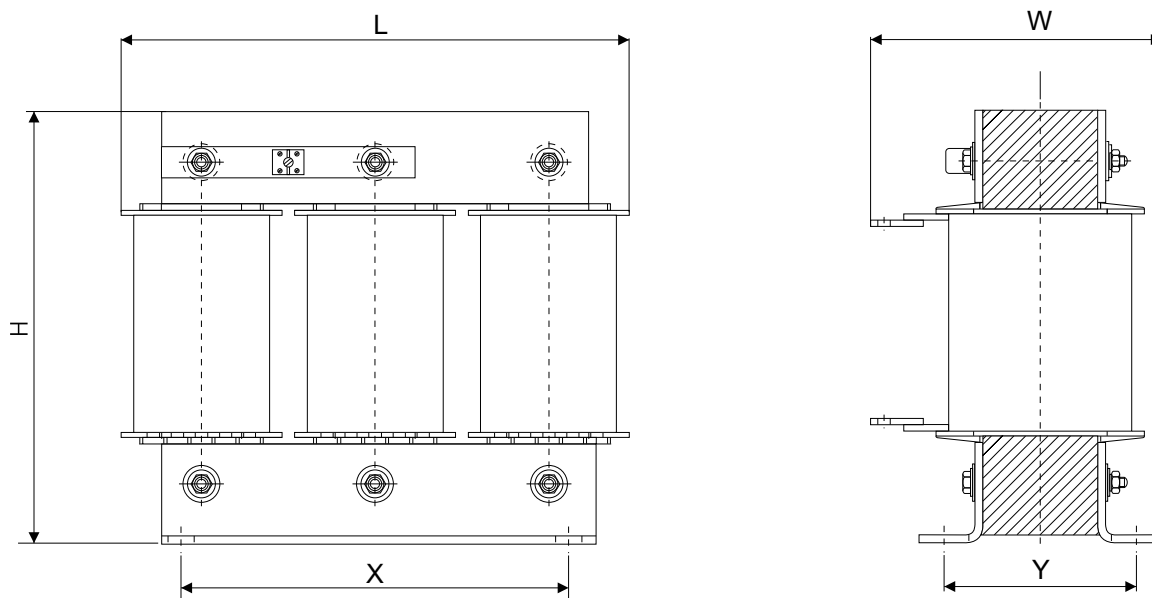

Technical specifications

General characteristics	
Standards	IEC/EN60076-6
Rated voltage (Un)	200V to 690V
Frequency (In)	50Hz
Power range	10 to 100 kvar (Ordered for special sizes)
Resonance frequency	6% - 204Hz / 7% - 189 Hz / 14% - 134Hz
Impedance ratio / model	P= 6% of Capacitor Value / BRH3-6 P= 7% of Capacitor Value / BRH3-7 P= 14% of Capacitor Value / BRH3-14
Tolerance of inductance	+/- 3% at Effective Current (Ieff)
The harmonic content of line voltage	U3 = 0.5%, U5 = 6%, U7 = 5%, U11 = 3.5%, U13 = 3%
Maximum current including harmonics overload	1.5 Times the Capacitor current
Insulation level	1.1 kV
Insulation strength testing voltage	3kV / 1min
Construction	
Design	Three phase, iron core with multi air gap
Coil winding material	Aluminium [Copper on request]
Duty cycle	Continuous
Vacuum impregnation	Yes
Working conditions	
Temperature category	- 25°C to +55°C
Maximum reactor operating temperature	135°C at ambient temperature 45°C
Insulation class	Class F / H (155°C / 180°C)
Max altitude	2000 m
Max relative humidity	95%
Linearity of Inductance	1.8 x I _c
Statistical life expectancy	> 200,000 hours
Installation characteristics	
Ventilation	Air-Cooled
IP Class	IP 00 [Indoor]
Noise level	Below 63db
Safety features	
Thermal overvload protection	Built-in thermostat cut off at 135°C

For p = 7% reactor, with 440V/50Hz capacitor at 380-400V/50Hz only

Product code	Q _c (440V)	Reactor Inductance	Dimension (mm)					Fixing Holes	Irms	R	Total Loss
	kVAR	mH	L	W	H	X	Y	mm	A	Ohm	W
BRH3740010	10	4.31	190	136	205	90	85	Φ8x12	14.5	58.6	74.8
BRH3740015	15	2.88	190	144	205	100	95	Φ8x12	21.8	30.2	82.3
BRH3740020	20	2.16	225	165	195	120	105	Φ10x20	28.6	17.5	113
BRH3740025	25	1.73	240	165	200	210	115	Φ10x20	35.7	11.8	143
BRH3740030	30	1.44	250	170	200	210	115	Φ10x20	42.8	9.82	161
BRH3740040	40	1.08	275	175	230	210	130	Φ10x20	57.1	7.37	215
BRH3740050	50	0.86	275	175	230	210	130	Φ10x20	71.5	5.36	240
BRH3740060	60	0.72	300	180	260	210	130	Φ10x20	85.7	4.19	260
BRH3740070	70	0.62	300	210	260	265	130	Φ10x20	100.0	3.45	281
BRH3740075	75	0.58	300	220	260	265	140	Φ10x20	107.0	3.05	308
BRH3740080	80	0.54	300	220	260	265	145	Φ13x22	114.2	2.67	327
BRH37400100	100	0.43	300	230	290	265	150	Φ13x22	142.8	1.64	380

C
Low voltage
series reactor

For p = 14% reactor, with 525V/50Hz capacitor at 380-415V/50Hz only

Product code	Q _c (525V)	Reactor Inductance	Dimension (mm)					Fixing Holes	Irms	R	Total Loss
	kVAR	mH	L	W	H	X	Y	mm	A	Ohm	W
BRH31440010	10	12.3	190	156	205	150	105	Φ8x12	11.0	118	82.7
BRH31440015	15	8.19	240	161	210	210	115	Φ10x22	16.5	60.5	119.4
BRH31440020	20	6.14	290	171	210	210	125	Φ10x20	22.0	35.1	180
BRH31440025	25	4.91	290	185	235	210	130	Φ10x20	27.5	23.6	215
BRH31440030	30	4.09	295	195	235	210	140	Φ10x20	33	19.6	238
BRH31440040	40	3.07	300	200	265	265	150	Φ10x20	44	14.7	242
BRH31440050	50	2.46	330	200	290	265	150	Φ10x20	55	10.8	268
BRH31440060	60	2.05	330	200	290	265	150	Φ10x20	66	8.38	288
BRH31440070	70	1.76	350	215	315	265	175	Φ10x20	77	6.90	334
BRH31440075	75	1.64	350	215	315	265	175	Φ10x20	82.5	6.10	340
BRH31440080	80	1.54	350	240	315	265	175	Φ13x22	88	5.35	350
BRH314400100	100	1.23	420	250	315	265	150	Φ13x22	110	3.25	382

Medium voltage series reactor

Application

These products, also known as detuned reactors or filter reactors, are typically used in series with medium voltage capacitors in Power Factor Correction (PFC) systems. They are employed to achieve the desired induced current, thereby enhancing power factors and limiting harmonic currents.



Salient Features

- Very High Linearity
- Lower Temperature Rising
- Can withstand 25 times short-circuit current in one second
- Easy Pad Termination & Mounting
- VPI Process Control
- Copper Connections
- Type Testing According to EN Standards

Technical specifications

General characteristics	
Standards	IEC/EN60076-6
Rated voltage (Un)	1kV to 35kV
Frequency (In)	50Hz
Power range	100 to 2500 kvar (Ordered for special sizes)
Resonance frequency	6% - 204Hz / 7% - 189 Hz / 14% - 134Hz
Impedance ratio / model	P= 6% of Capacitor Value P= 7% of Capacitor Value P= 14% of Capacitor Value
Tolerance of inductance	+/- 3% at Effective Current (Ieff)
The harmonic content of line voltage	U3 = 0.5%, U5 = 6%, U7 = 5%, U11 = 3.5%, U13 = 3%
Construction	
Design	Three phase, iron core with multi air gap
Coil winding material	Aluminium (Copper on request)
Duty cycle	Continuous
Vacuum impregnation	Yes
Working conditions	
Temperature category	- 25°C to +55°C
Maximum reactor operating temperature	135°C at ambient temperature 45°C
Insulation class	Class H (180°C)
Max altitude	2000 m
Max relative humidity	95%
Linearity of Inductance	1.55 ~ 2.2 x Ic
Statistical life expectancy	> 200,000 hours
Installation characteristics	
Cooling method	Natural air
Terminals	Copper bar
IP Class	IP 00 (Indoor)
Noise level	Below 65db

Dimension and structure

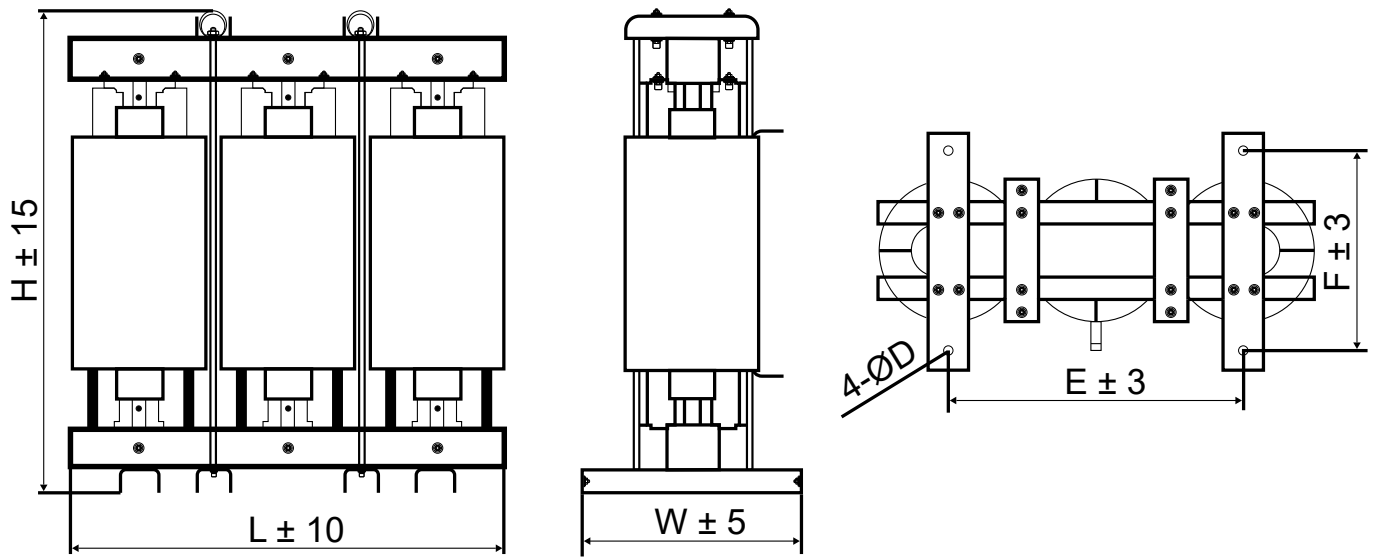

Reactor p = 7%

Product code	Q_c	U_N/U_c	L_N	Dimension (mm)		I_{rms}	Weight
	kVAR	kV	mH	L x W x H	E x F	A	kg
BRH376D3100	100	6.3/6.9	106	700 x 400 x 720	460 x 300	9.5	125
BRH376D3150	150		70.7	700 x 400 x 785	460 x 300	14.2	140
BRH376D3200	200		53.0	700 x 400 x 855	460 x 300	18.9	155
BRH376D3300	300		35.4	750 x 400 x 1000	500 x 300	28.4	180
BRH376D3600	600		17.7	800 x 450 x 1070	540 x 350	56.7	300
BRH376D3900	900		11.8	950 x 500 x 1060	640 x 400	85.1	420
BRH376D31500	1500		7.07	1100 x 550 x 930	720 x 450	141.8	520

BRH3711150	150	11/12	214	800 x 400 x 740	540 x 300	8.1	200
BRH3711300	300		107	850 x 400 x 970	580 x 300	16.3	282
BRH3711500	500		64.2	950 x 450 x 990	640 x 350	27.2	310
BRH3711600	600		53.5	950 x 500 x 1110	640 x 400	32.7	350
BRH3711900	900		35.7	1000 x 500 x 1100	660 x 400	48.9	450
BRH37111500	1500		21.4	1150 x 550 x 1280	780 x 450	81.6	550

Discharge Reactor

Application

In a volatile reactive power environment, discharge reactors reduce discharge time and increase the lifetime of capacitors in a power factor correction system.

Salient Features

- Reduces discharge time of capacitors for fast-changing reactive power demands
- Low loss
- Compact design
- Up to 100 kVAR discharging
- Up to 690V operating voltage
- DIN rail-mountable shockproof casing
- CE mark and manufactured under ISO 9001 quality management system

Dimension and structure

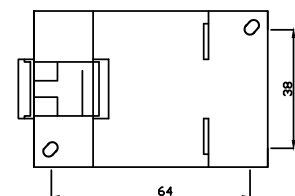
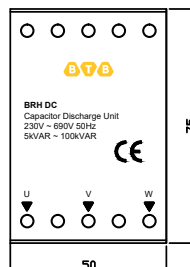
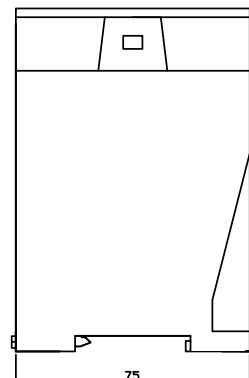
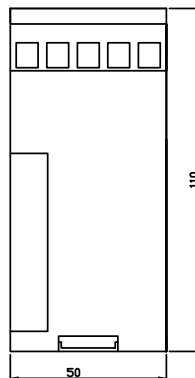

Technical specifications

General characteristics	
Product code	BRHDC
Design	Resistors
Resistance value	6k Ω
Rated voltage (Un)	200V to 690V
Frequency (In)	50Hz
Capacitor capacity	5 to 100 kvar
Working conditions	
Temperature category	- 5°C to +55°C
Max altitude	2000 m
Max relative humidity	95%
Insulation strength testing voltage	3kV
Statistical life expectancy	> 200 000 hours
Installation characteristics	
Mounting	Clip on DIN Rail (35 mm x 7.5 mm)
Location in diagram	Mounted behind the Contactor
IP Class	IP 00 [Indoor]
Time to discharge voltage below 50V	
Discharge time 250V	up to 25 kVAr < 10 s up to 50 kVAr < 20 s
Discharge time 400V - 525V	up to 25 kVAr < 5 s up to 50 kVAr < 10 s up to 100 kVAr < 20 s
Discharge time 690V	up to 25 kVAr < 3 s up to 50 kVAr < 5 s up to 100 kVAr < 10 s

Power Factor Relay

Application

Power Factor Controllers are used for the measurement and regulation of power factor control units in central reactive power compensation systems. The power factor measured by the PFR is compared with the set point values to determine the necessary compensation. The Power Factor Controller then automatically switches capacitor steps ON and OFF as needed. The PFR is a microcontroller-based relay, designed for flush mounting with rear plug-in connectors. Additionally, it displays the system's power factor (Cos ϕ). In Automatic Operating Mode, the PFR also displays the RMS values of Voltage (V), Current (I), Active Power (W), Reactive Power (kvar), and Apparent Power (VA) of the measuring phase.

Salient Features

Standard PFR

- Manual, auto switching control
- Automatic C/K and rated step adjustment
- Automatic CT polarity correction
- Alarm Relay
- User-friendly setting
- Complies with IEC 61000-6-2 standard

Special PFR

- Manual, auto switching control
- Set COS coefficients separately for grid and generator.
- Protection voltage, temperature and THDu
- RS-485 Communication
- Connection Angle $0^\circ \sim 330^\circ$
- Complies with IEC 61000-6-2 standard



Power Factor Relay

Technical specifications - Standard PFR

Auxiliary Supply	
Rated voltage (Un)	240V/415V
Operating voltage Range	±10%
Frequency (In)	50/60Hz
Power consumption	3VA – 10VA
Current Input	
Rated current (In)	5A
Operating current range	50mA ~ 5.5A
Power consumption	2VA max
Frequency (In)	50/60Hz
Relay Output	
Numbers of outputs	6 / 8 / 12 (PFR96b, PFR60b/ PFR80b / PFR120b)
Output contact	5 A, 250V (NO Contact)
Expected electrical life	≥ 100,000 operations at rated current
Expected mechanical life	≥ 5,000,000 operations
No-Volt Feature	In case of power failure longer than 200 msec, all capacitor steps are disconnected
Alarm relay	1 (NO Contact)
Control Range	
Cosφ setting	0.85 (ind.) - 1.00
C/k setting	Automatic / 0.02-1.0
CT value	5 - 10000/5
Time delay (on, off) and Discharge Time Setting	Between 2 ~1800 sec; (2 ~ 50 sec for 96b)
Over voltage values	240-275V (265) / 410-480V (475)
Switching program	PS1 – PS5
Display	
Display screen	LED
Measure	Cosφ, PF, V, I, W, Var, VA
Environmental Conditions	
Ambient temperature	-5°C - 55°C
Humidity	5% - 95% non-condensing
Box protection class	IP 54 (front panel)
Equipment protection class	Double Insulation-Class II
Mechanical	
Mounting	Panel mounting
Connections	Socket terminals with screw
Dimension (HxWxD)	144x144x67mm / 96x96x91mm
Switchboard cut-out	139x139mm / 91x91mm
Weight	0.8kg / 0.45kg

Technical specifications - Special PFR

Auxiliary Supply	
Rated voltage (Un)	230V
Operating voltage Range	±10%
Power consumption	10VA max
Generator Input	110 ~ 250V
Frequency (In)	50/60Hz
Voltage Measurement Input	
Rated voltage	10 ~ 500V
Power consumption	10VA max
Current Measurement Input	
Rated current (In)	5A
Operating current range	50mA ~ 5.5A
Power consumption	2VA max
Relay Output	
Numbers of outputs	6 / 8 (PFR96Bs); 12 (PFR120Bs)
Output contact	5 A, 250V AC, 1250VA (NO)
Expected electrical life	≥ 100,000 operations at rated current
Expected mechanical life	≥ 5,000,000 operations
Alam relay / Fan relay	1NO / 1NO
Control Range	
Cosφ 1 setting	0.80 (ind.) ~ -0.8 (cap)
Cosφ 2 setting (generator input on)	0.80 (ind.) ~ -0.8 (cap)
CT ratio / VT ratio	1 ~ 2000 / 1 ~ 2000
Time delay (on, off)	Between 2 ~ 1800 sec
Over voltage values	240-275V (265)
Switching program	01 ~ 10
Display	
Display screen	Red LED display with 4 digits
Measure	Cosφ, V, I, W, Var, VA, °C, THD
Environmental Conditions	
Ambient temperature	-5°C - 55°C
Humidity	5% - 95% non-condensing
Box protection class	IP 54 (front panel)
Mechanical	
Mounting	Panel mounting
Connections	Socket terminals with screw
Dimension (HxWxD)	143x143x67mm / 96x96x91mm (PFR96Bs)
Switchboard cut-out	139x139mm / 91x91mm
Weight	0.85kg / 0.45kg

Dimension and structure

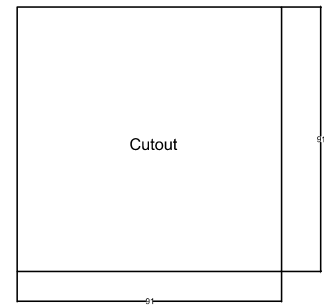
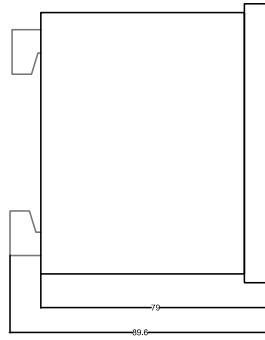
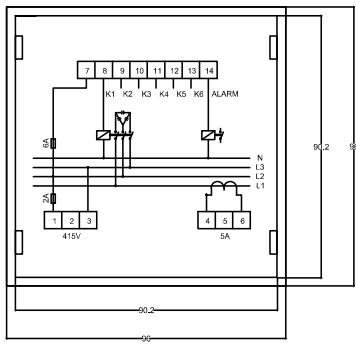

PFR96B / PFR96Bs 96x96x91mm

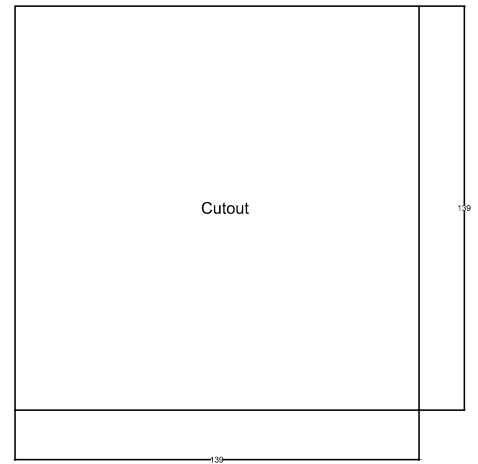
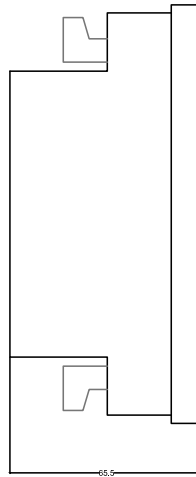
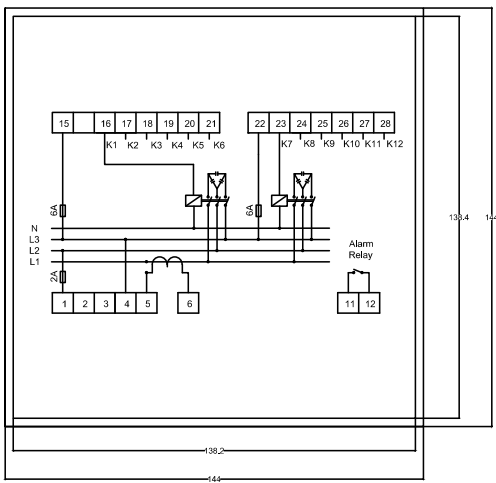

PFR60B, PFR80B, PFR120B, PFR120Bs 143x143x67mm

Ordering Information

Product code	Explain
PFR96bN7	6 steps, system voltage is 415V, dimensions 96x96mm
PFR60bN7	6 steps, system voltage is 415V, dimensions 144x144mm
PFR80bN7	8 steps, system voltage is 415V, dimensions 144x144mm
PFR120bN7	12 steps, system voltage is 415V, dimensions 144x144mm
PFR96Bs6M7	6 steps, system voltage is 230 ~ 415V, dimensions 96x96mm
PFR96Bs8M7	8 steps, system voltage is 230 ~ 415V 415V, dimensions 96x96mm
PFR120BsM7	12 steps, system voltage is 230 ~ 415V 415V, dimensions 144x144mm
PFR96bU7	6 steps, system voltage is 240V, dimensions 96x96mm
PFR60bU7	6 steps, system voltage is 240V, dimensions 144x144mm
PFR80bU7	8 steps, system voltage is 240V, dimensions 144x144mm
PFR120bU7	12 steps, system voltage is 240V, dimensions 144x144mm

Intelligent power factor relay

Application

PFR-Z is an integrated controller for reactive power compensation and power distribution monitoring. It integrates data acquisition, communication, reactive power compensation, grid parameter measurement, and analysis. With RS485 communication, it controls 32 pieces of intelligent capacitors (mixed or three-phase compensation).

Salient Features

- Capable of controlling up to 32 intelligent capacitors
- Supports mixed or three-phase compensation control
- Provides protective functions for overvoltage ($U>$), undervoltage ($U<$), overcurrent ($I>$), and Total Harmonic Distortion (THD)
- Equipped with an RS485 communication interface



Technical specifications

General Characteristics	
Standards	JB/T 9663-2013
Product code	PFRZxxBIC / PFRDxxBIC
Rated voltage (Un)	220V \pm 20%
Frequency (fn)	50Hz \pm 10%
Measurement and Control	
Measurement accuracy	Voltage: $\leq \pm 0.5\%$ (0.8~1.2Un), Current: $\leq \pm 0.5\%$ (0.2~1.2In) Reactive power: $\leq \pm 2\%$, Power factor: $\leq \pm 1\%$
Control quantity	PFR-Z: RS485 communication control 32 pieces of intelligent capacitors (mixed or three-phase compensation) or 16 pieces of communication type composite switches. PFR-D: 12V output control 12 steps or 16 steps (composite switch node)
Compensation method	Mixed or three-phase compensation
Working Conditions	
Temperature category	- 25°C to +55°C (class D)
Max altitude	2000 m
Max relative humidity	Relative humidity $\leq 50\%$ at 40°C; $\leq 90\%$ at 20°C
Environmental condition	No harmful gas and steam, no conductive or explosive dust, no severe mechanical vibration
Mounting position	Indoor, upright
THDv	$\leq 5\%$
Safety Features	
Protective function	Over-voltage protection, under-voltage protection, over-current protection, over-harmonic protection
Communication Monitoring Capability	
Communication interface	RS485
Communication protocol	Modbus protocol

Dimension and structure

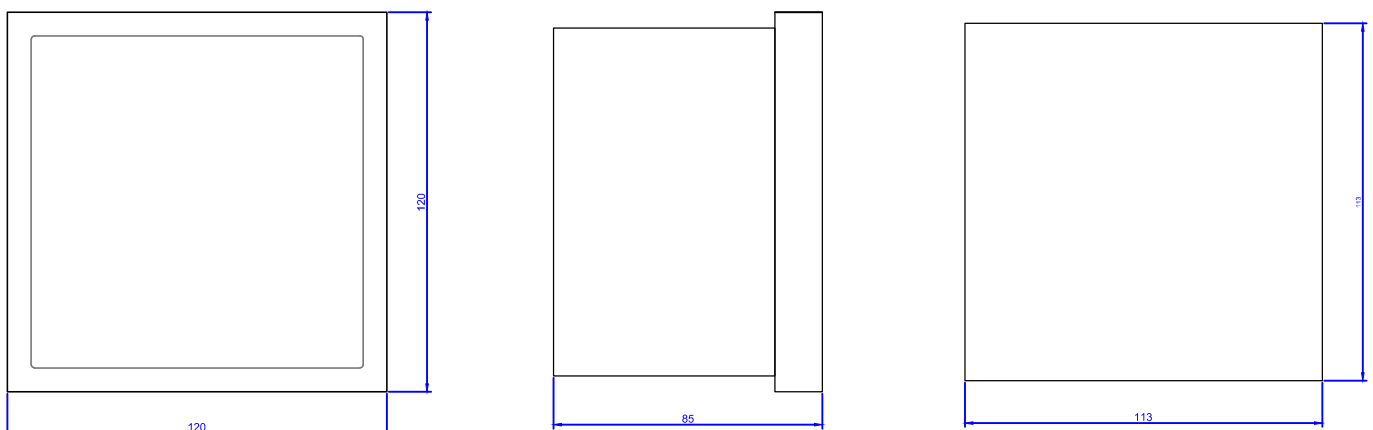

Capacitor Duty Contactor

Application

In low-voltage installations, when a capacitor is switched on, it results in a resonant circuit damped to a greater degree. In addition to the rated current, overcurrent of high amplitude ($> 180 I_n$) and high frequencies (3 ~ 15 kHz) occur during the transit period (1 to 2 ms). The resultant high inrush current peaks, caused due to capacitor switching, depend upon factors such as network inductances, transformer power and short circuit voltage, and harmonics presence in the system. The inrush current of such high magnitudes is undesirable and is likely to weld the main poles of any standard contactor.

Capacitor contactors are specially designed to meet the stringent requirements of capacitor switching as deliberated above. The contactors are fitted with a front-mounted block of 3 early make auxiliary contacts in series with quick discharge damping six resistors – 2 per phase to limit peak current to a value within the contactor's making capacity. This ensures that the normal rated capacitor current is carried by the main contacts which, after closing, effectively short out the resistors.

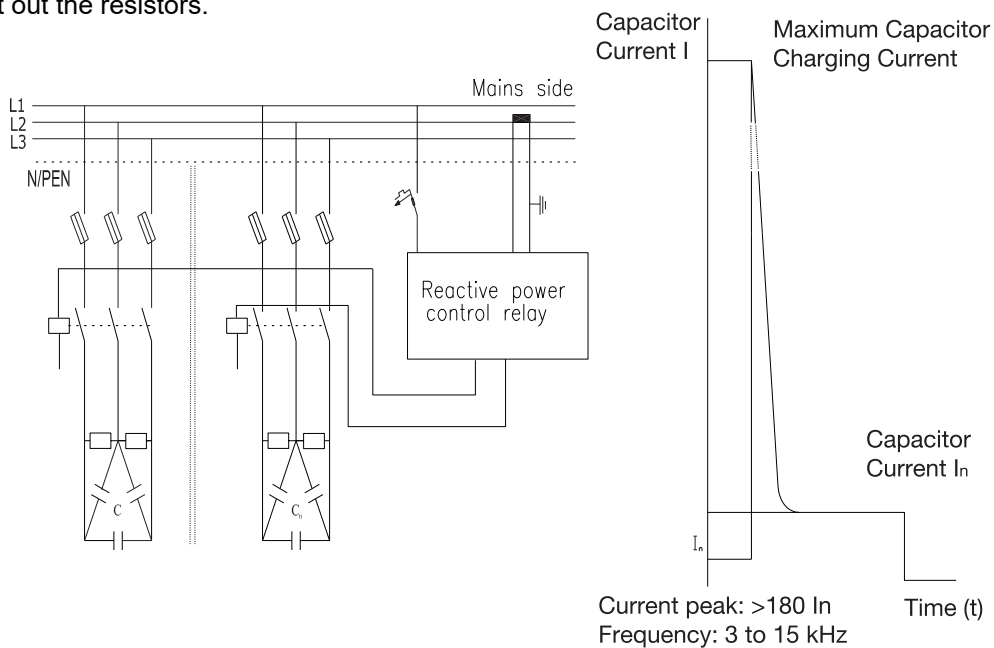

Salient Features

- Damping of inrush current
- Low ohmic losses
- Power quality improvement
- Enhanced equipment life
- Low maintenance and downtime
- Optimized solution cost
- Capacitor bank switching in parallel without derating (Permanent current that can reach 1.5 time the nominal current of capacitor bank)



BTB
Capacitor Duty
Contactor

Technical specifications

General characteristics	
Reference Standard	IEC 60947-4-1
Number of poles	3 poles
Rated Operational Voltage (Ue)	690V
Rated Insulation Voltage (Ui)	690V
Impulse Withstand Voltage (Uimp)	8kV
Rated Frequency	50/60Hz
Contactors fitted with a block of early make poles and damping resistors	Yes
Prospective peak current at switch-on	200In
Electrical durability at nominal load (all contactor ratings)	400V: 300000 operating cycles 690V: 200000 operating cycles

Product Code	Operating power at 50/60Hz $\theta \leq 55^{\circ}\text{C}$ (kVA _r)*			Rated current (A)	Instantaneous auxiliary contacts ***		Maximum operating rate (Operations/hours)	Weight kg
	200/240V	400/440V	660/690V		NO	NC		
BCC05K11**	4	7	10.2	10	1	1	240	0.5
BCC10K11**	5.5	10	14.3	14	1	1	240	0.5
BCC12K11**	6.7	12.5	18	18	1	1	240	0.5
BCC15K11**	8.5	16.7	24	24	1	1	240	0.5
BCC20K11**	10	20	30	29	1	1	240	0.7
BCC25K11**	15	25	36	36	1	1	240	0.7
BCC30K12**	20	33.3	48	48	1	2	240	1.5
BCC40K12**	25	40	58	58	1	2	100	1.5
BCC50K12**	30	50	72	70	1	2	100	1.5
BCC60K12**	40	60	92	92	1	2	100	1.8
BCC75K12**	45	75	120	108	1	2	100	1.8
BCC100K12**	60	100	143	144	1	2	100	2.5

*) The average temperature over a 24-hour period, in accordance with standards IEC 60070 and 60831 is 45°C

**) The contactor coil code is not specified

***) The maximum instantaneous auxiliary contact option is 2NO+3NC

Control circuit voltage (Uc)	24V	110V	220V	240V	415V
Coil code 50Hz	B5	F5	M5	U5	N5
Coil code 50/60Hz	B7	F7	M7	U7	N7
Operating range at $\leq 60^{\circ}\text{C}$	0.8 ~ 1.1Uc				
Drop-out	0.3 ~ 0.6 Uc				

Dimension and structure

BCC-10K11, 15K11			BCC-20K11, 25K11		
BCC	10K11	15K11	BCC	20K11	25K11
C	80	85	C	93	98
G	117	122	G	130	135

BCC-30K12, 40K12, 50K12		BCC-60K12, 75K12	

100K12		

Switch Series

Application

The BCS series composite switch utilizes a combination of thyristor switch and magnetic holding switch, operating in parallel. It leverages the benefits of thyristor zero-crossing switching during power on and off, coupled with the advantage of zero power consumption from the magnetic holding switch during regular operations. This switch offers significant advantages such as shock-free operation, low power consumption, and extended service life. It can effectively replace contactors or thyristor switches and finds widespread application in low-voltage reactive power compensation systems.



Salient Features

- Built-in microprocessor and intelligent software enable intelligent control of capacitor switching
- The product achieves zero-crossing switching, eliminating arcs and inrush current, with rapid response
- Zero on-resistance ensures no generation of harmonics
- Non-heating design allows installation in a closed box
- Low failure rate and significantly longer service life compared to thyristors and contactors

Technical specifications

General characteristics	
Standards	IEC 60947-4-1
Product code	BCW3845, BCW3870, BCW2245, BCW2270
Rated voltage (Un)	380VAC \pm 20%
Frequency (fn)	50Hz \pm 10%
Performance	
Rated working current	2mA
DC control voltage	DC8~18V
DC control current	2~10mA
Service life	300000 time
Working conditions	
Temperature category	- 25°C to +55°C (class D)
Max altitude	2500 m
Max relative humidity	Relative humidity \leq 50% at 40°C; \leq 90% at 20°C
Environmental condition	No harmful gas and steam, no conductive or explosive dust, no severe mechanical vibration
Mounting position	Indoor
Rail or bolt mounting	35mm rail installation; or M4x 35mm bolt installation, mounting size: 117 \times 28mm
BCS	
380-45- Δ (Z) three phase compensation	Control capacity \leq 30, control current 45A, Control number of poles 3P
380-70- Δ (Z) three phase compensation	Control capacity \leq 40, control current 70A, Control number of poles 3P
220-45-Y (Z) split phase compensation	Control capacity \leq 10kvar / phase \times 3, Control current 45A, Control number of poles A + B + C
220-70-Y (Z) split phase compensation	Control capacity \leq 13kvar / phase \times 3, Control current 70A, Control number of poles A + B + C

Dimension and structure

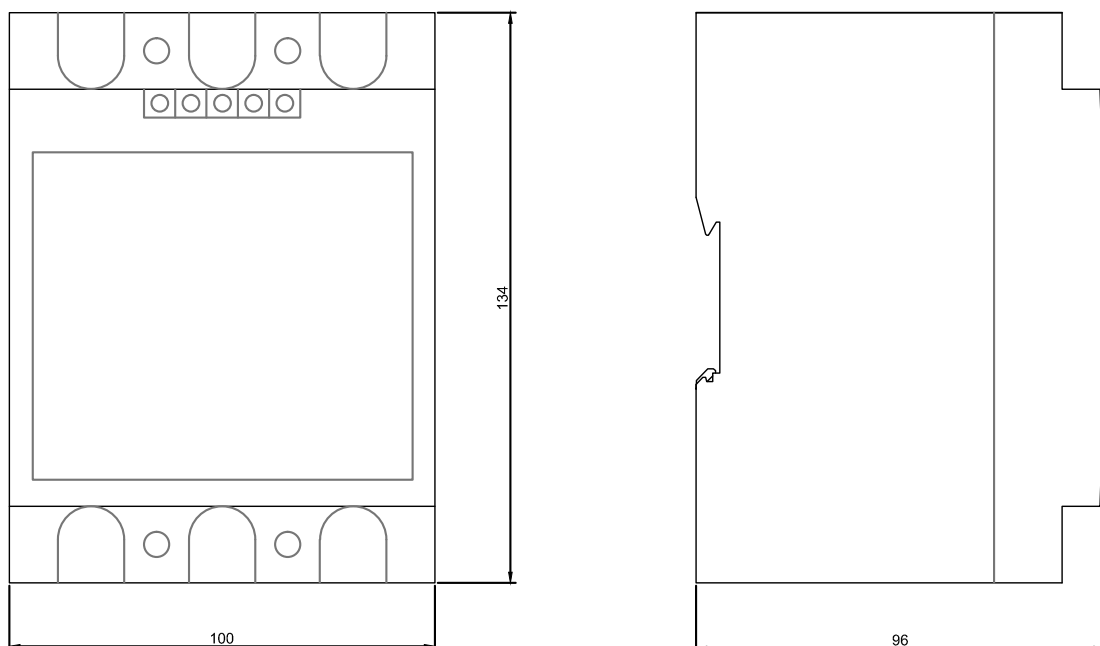

Active Harmonic Filter

Application

Active Harmonic Filters (AHF) are connected in parallel to the low-voltage side of the power grid to enhance power quality. With smart control capabilities, high efficiency, rapid dynamic response, and stable, reliable operation, they effectively address complex power quality issues, ensuring optimal power quality levels are achieved.



Salient Features

- Harmonic Compensation: AHF can filter 2 to 50 times random harmonics simultaneously
- Reactive Power Compensation: Stepless compensation for both capacitive and inductive (-1 to 1)
- Fast Response: Swift reaction time to power quality issues
- Design Life: Exceeds 100,000 hours (equivalent to more than ten years of operation)

Technical specifications

General characteristics	
Standards	JB/T 11067-2011, DL/T 1216-2013 IEC/EN 60439-1, 2014/30/EU, EN 61000-6
Rated input line voltage	380V ±20%
Frequency (fn)	50Hz ±10%
Compensation current	50A, 75A, 100A, 150A per module 200A, 300A, 400A, 450A, 500A, 600A per cabinet
Power grid structure	3P3W / 3P4W
Performance specifications	
Operating mode	Active harmonic filtering / Power factor correction / Load balancing
Compensation efficiency	≥ 97%
Harmonic spectrum	2nd to 50th harmonics
Harmonic compensation selection	Individual selection from 2nd to 50th harmonics
Response time	Instantaneous response time < 0.1ms Full response time < 10ms
Power factor correction	Power factor programmable from 1 (inductive) to -1 (capacitive)
Load balancing	Programmable load balancing between phases
Protections	Over-voltage protection, under-voltage protection, short-circuit protection, over-current protection, over-temperature protection, drive fault protection
Operation configuration	
Parallel operation	Supports up to 8 modules with different rated currents
CT requirements	Requires 3 CTs ranging from 100/5A to 5000/5A, with a class of 0.5
Circuit topology	Utilizes a three-level topology
Power loss	Less than 3% of rated power
Communication monitoring capability	
Communication interface	RS485, CAN interface
Communication protocol	Modbus protocol
Module display interface	Optional LCD multi-function touch color screen
Error alarm	Support independent monitoring or centralized monitoring
Environmental conditions	
Operation temperature	-10 ~ 40°C (derating required for higher temperatures)
Humidity	≤ 95% non-condensation
Altitude	≤ 1500m, derating of 1% per 100m between 1500m to 3000m
Environmental conditions	No harmful gas and steam, no conductive or explosive dust, no severe mechanical vibration
Intelligent air cooling	Ensures excellent ventilation
Protection class	IP20 (higher protection class available on request)
Noise level	Below 65dB

Dimension and structure

1. Drawer type and wall-mounted type

Code	Dimension (W×H×D) mm		Mounting dimension(W×H) mm	
	Drawer type	Wall-mounted type	Drawer type	Wall-mounted type
BF3-05044LD BF3-05044LW	500×160×558	500×545×173	478×130 480×250	480×250
BF3-07544LD BF3-07544LW	500×160×558	500×545×173	478×130 480×250	480×250
BF3-10044LD BF3-10044LW	555×260×665	555×665×260	530x150 535x350	535x350
BF3-15044LD BF3-15044LW	555×260×665	555×665×260	530x150 535x350	535x350

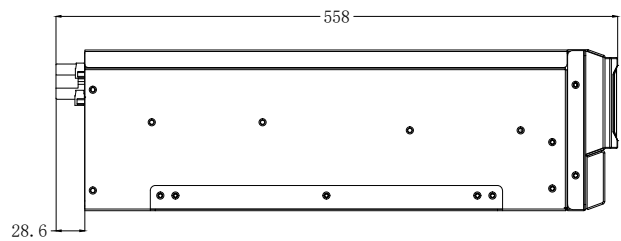
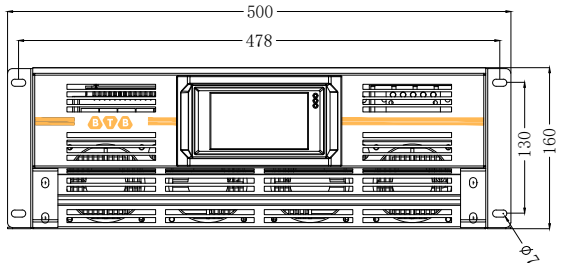
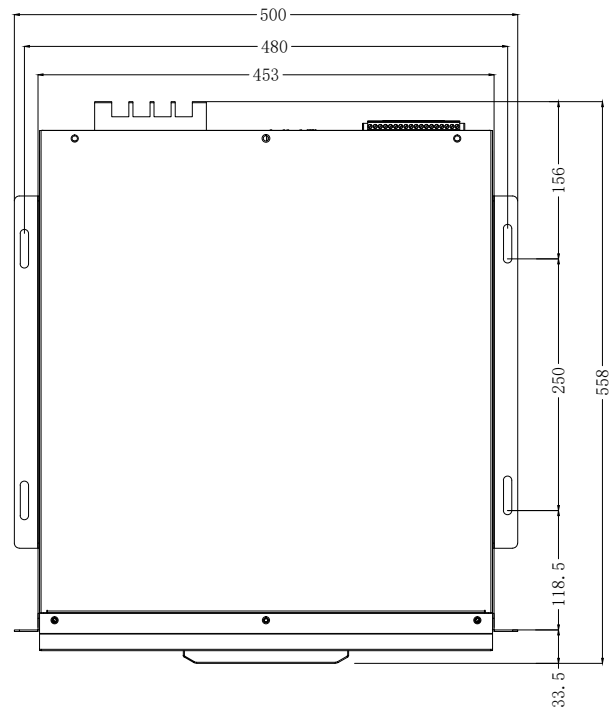
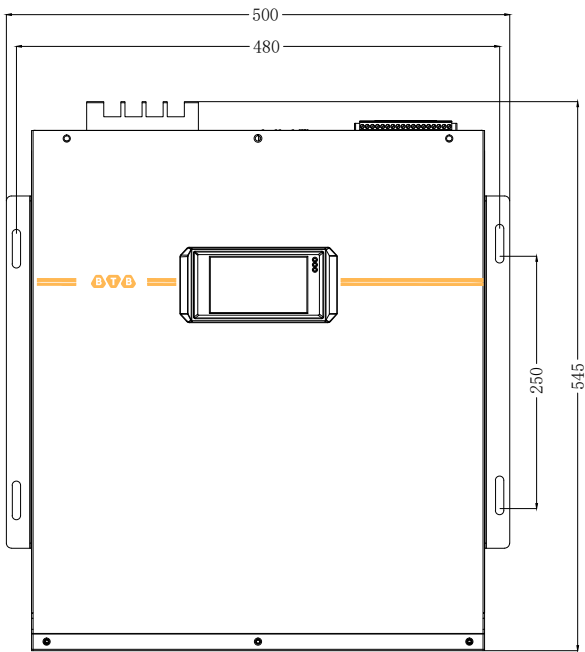

2. Cabinet type

Code	Installation	Dimension (W×H×D) mm
BF3-20044LC	2 modules	800x2200x800
BF3-25044LC	2 modules	
BF3-30044LC	2 modules or 3 modules	
BF3-35044LC	3 modules	
BF3-40044LC	3 modules or 4 modules	
BF3-45044LC	3 modules or 4 modules	
BF3-50044LC	4 modules	
BF3-60044LC	4 modules	

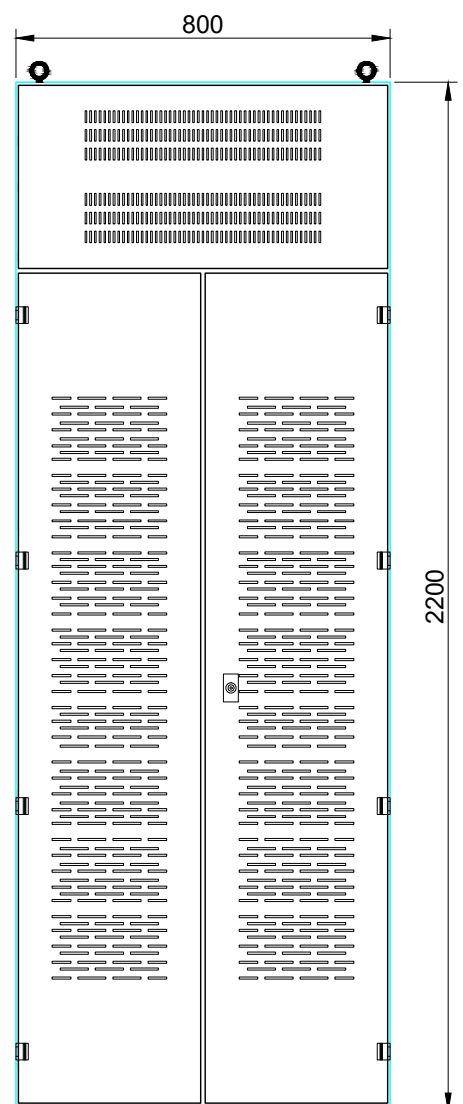
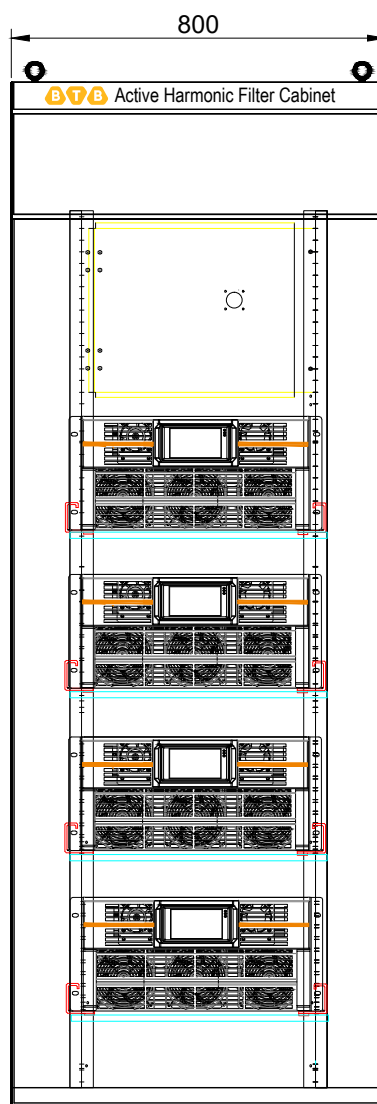
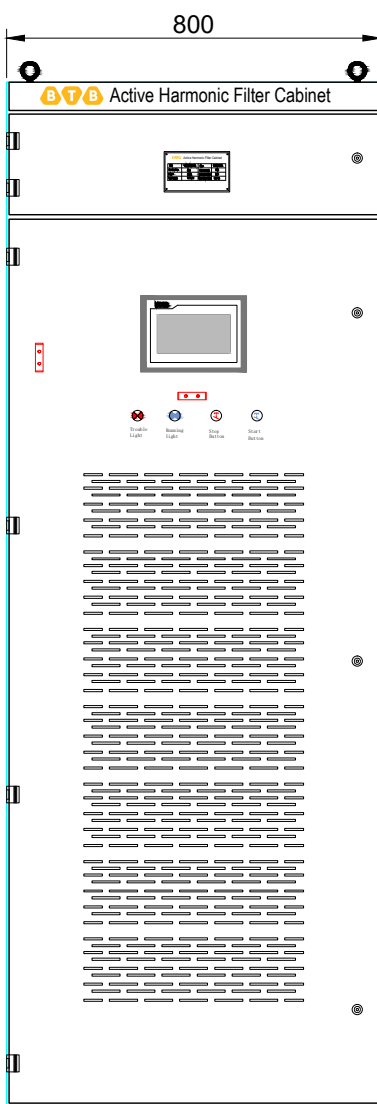



**REALVALUE
FOR LIFE**

Designed by BTB Electric
Add: Orhangazi Mah. Mimsan San. Sit. 1780 sok.
No: 5 Esenyurt / İstanbul / Türkiye
E-mail: sales@btb-electric.com
Web: btb-electric.com

